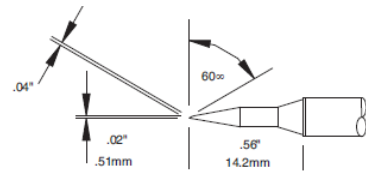
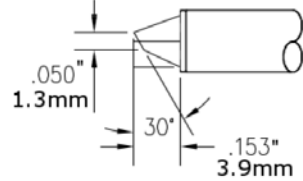
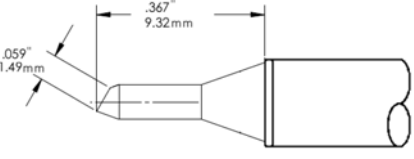
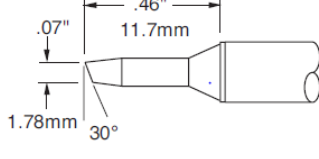
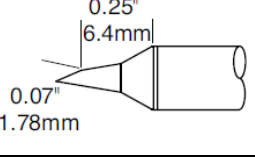
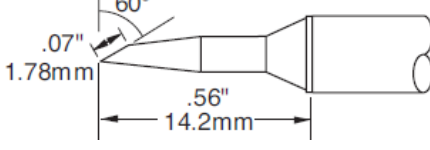

CVC & SMC Cartridges are compatible with MX-500, MX-5000, MX-5200 and CV-5200 Systems – MX-RM3E, MX-H1-AV and CV-H1-AV Hand pieces

STTC & SMTC Cartridges are compatible with MX-500, MX-5000 and MX-5200 Systems – MX-RM3E and MX-H1-AV Hand pieces

Temperature	STTC/SMTC	CVC/SMC	Application
302 °C	STTC-5xx	CVC-5xxx	Temperature Sensitive
357 °C	STTC-0xx	CVC-6xxx	
412 °C	STTC-1xx	CVC-7xxx	Most Standard
468 °C	STTC-8xxV1	CVC-8xxx	Ceramic and High Thermal Demand
510 °C	STTC-8xx	CVC-9xxx	

Please note the above temperatures are the maximum temperatures of the heater. The idle temperature is dependent on the geometry of the cartridge (up to 15°C lower.)

Bevel			
	CVC-5BV6005A CVC-6BV6005A CVC-7BV6005A CVC-8BV6005A CVC-9BV6005A	STTC-546 STTC-046 STTC-146 STTC-846V1 STTC-846	Long Reach Bevel 60° 0.50mm x 14.2mm (.04" x .56")
	CVC-5BV3018P CVC-6BV3018P CVC-7BV3018P CVC-8BV3018P CVC-9BV3018P	STTC-515 STTC-015 STTC-115 STTC-815V1 STTC-815	Bevel, 30° P = Optimised geometry for best thermal performance 1.3mm x 3.9mm (.05" x 0153")
	CVC-5BV4001S CVC-6BV4001S CVC-7BV4001S CVC-8BV4001S CVC-9BV4001S	STTC-524 STTC-024 STTC-124 STTC-824V1 STTC-824	Bevel 30° 1.5mm x 9.3mm (.059" x .367")
	CVC-5BV3018S CVC-6BV3018S CVC-7BV3018S CVC-8BV3018S CVC-9BV3018S	STTC-505 STTC-005 STTC-105 STTC-805V1 STTC-805	Bevel 30° 1.78mm x 11.7mm (.07" x .39")
	CVC-5BV6018P CVC-6BV6018P CVC-7BV6018P CVC-8BV6018P CVC-9BV6018P	STTC-547P STTC-047P STTC-147P STTC-847PV1 STTC-847P	Bevel 60° P = Optimised geometry for best thermal performance 1.78mm x 6.4mm (.07" x .25")
	CVC-5BV6018R CVC-6BV6018R CVC-7BV6018R CVC-8BV6018R CVC-9BV6018R	STTC-547 STTC-047 STTC-147 STTC-847V1 STTC-847	Long Reach Bevel 60° 1.78mm x 14.2mm (.07" x .56")

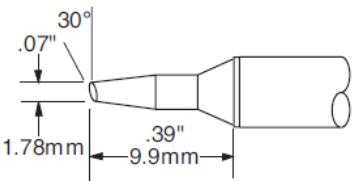
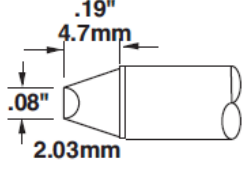
Bevel			
	CVC-5BV6018S CVC-6BV6018S CVC-7BV6018S CVC-8BV6018S CVC-9BV6018S	STTC-535 STTC-035 STTC-135 STTC-835V1 STTC-835	Bevel 30° 1.78mm x 9.9mm (.07" x .39")
	CVC-5CH0020S CVC-6CH0020S CVC-7CH0020S CVC-8CH0020S CVC-9CH0020S	STTC-514 STTC-014 STTC-114 STTC-814V1 STTC-814	Bevel 45° 2.0mm x 4.7mm (.08" x .19")

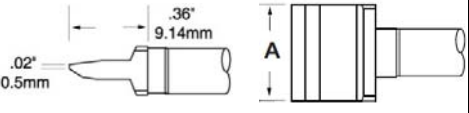
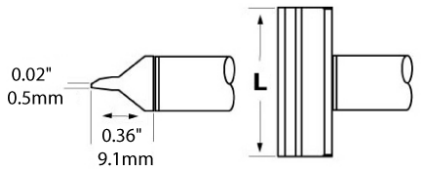
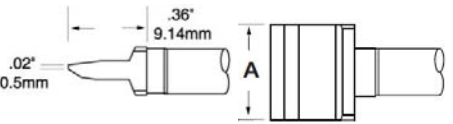
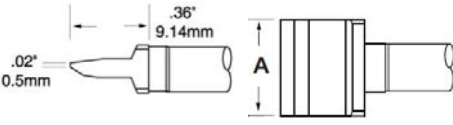
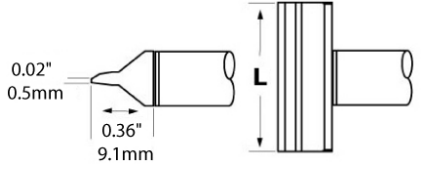
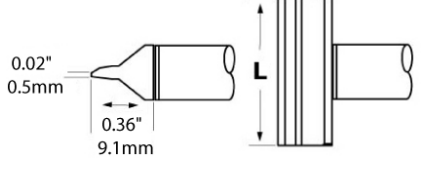
Blade			
	SMC-5BL0010S SMC-6BL0010S SMC-7BL0010S SMC-8BL0010S SMC-9BL0010S	SMTC-560 SMTC-060 SMTC-160 SMTC-860V1 SMTC-860	Blade Long A=10mm (.40")
	SMC-5BL0015H SMC-6BL0015H SMC-7BL0015H SMC-8BL0015H SMC-9BL0015H	SMTC-5BL150 SMTC-0BL150 SMTC-1BL150 SMTC-8BL150V1 SMTC-8BL150	Blade Short L=15mm (.59")
	SMC-5BL0016S SMC-6BL0016S SMC-7BL0016S SMC-8BL0016S SMC-9BL0016S	SMTC-561 SMTC-061 SMTC-161 SMTC-861V1 SMTC-861	Blade Long A=15.75mm (.62")
	SMC-5BL0022S SMC-6BL0022S SMC-7BL0022S SMC-8BL0022S SMC-9BL0022S	SMTC-562 SMTC-062 SMTC-162 SMTC-862V1 SMTC-862	Blade Long A=22mm (.86")
	SMC-5BL0025H SMC-6BL0025H SMC-7BL0025H SMC-8BL0025H SMC-9BL0025H	SMTC-5BL250 SMTC-0BL250 SMTC-1BL250 SMTC-8BL250V1 SMTC-8BL250	Blade Long L=25mm (1")
	SMC-5BL0035H SMC-6BL0035H SMC-7BL0035H SMC-8BL0035H SMC-9BL0035H	SMTC-5BL350 SMTC-0BL350 SMTC-1BL350 SMTC-8BL350V1 SMTC-8BL350	Blade Long L=35mm (1.38")

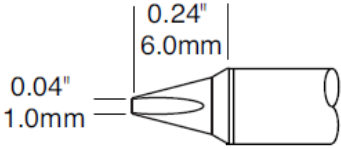
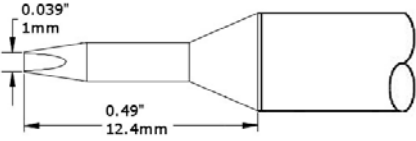
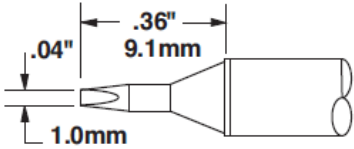
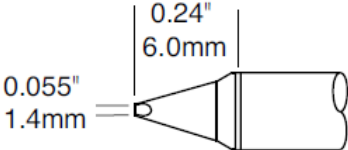
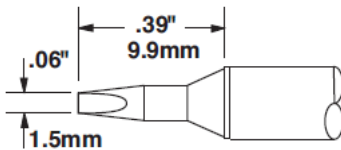
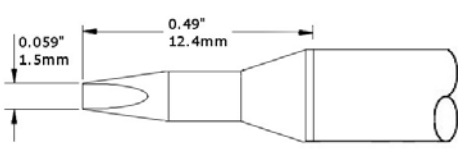
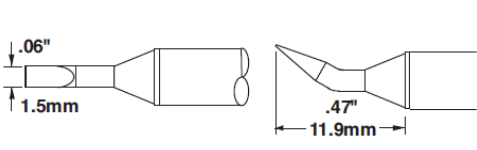
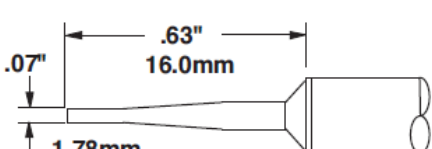
Chisel			
	CVC-5CH0010P CVC-6CH0010P CVC-7CH0010P CVC-8CH0010P CVC-9CH0010P	STTC-525P STTC-025P STTC-125P STTC-825PV1 STTC-825P	Chisel 30° P = Optimised geometry for best thermal performance 1.0mm x 6.0mm (.04" x .24")
	CVC-5CH0010A CVC-6CH0010A CVC-7CH0010A CVC-8CH0010A CVC-9CH0010A	N/A	Long Reach Chisel 30° 1.0mm x 12.4mm (.04" x .49")
	CVC-5CH0010S CVC-6CH0010S CVC-7CH0010S CVC-8CH0010S CVC-9CH0010S	STTC-525 STTC-025 STTC-125 STTC-825V1 STTC-825	Chisel 30° 1.0mm x 9.1mm (.04" x .33")
	CVC-5CH0014P CVC-6CH0014P CVC-7CH0014P CVC-8CH0014P CVC-9CH0014P	STTC-538P STTC-038P STTC-138P STTC-838PV1 STTC-838P	Chisel 30° P = Optimised geometry for best thermal performance 1.4mm x 6.0mm (.06" x .24")
	CVC-5CH0014S CVC-6CH0014S CVC-7CH0014S CVC-8CH0014S CVC-9CH0014S	STTC-538 STTC-038 STTC-138 STTC-838V1 STTC-838	Chisel 30° 1.5mm x 9.9mm (.06" x .39")
	CVC-5CH0015A CVC-6CH0015A CVC-7CH0015A CVC-8CH0015A CVC-9CH0015A	N/A	Long Reach Chisel 1.5mm x 12.4mm (.06" x 0.49")
	CVC-5CH0015R CVC-6CH0015R CVC-7CH0015R CVC-8CH0015R CVC-9CH0015R	STTC-599 STTC-099 STTC-199 STTC-899V1 STTC-899	Chisel Bent 30° 1.5mm x 11.9mm (.06" x .47")
	CVC-5CH0018A CVC-6CH0018A CVC-7CH0018A CVC-8CH0018A CVC-9CH0018A	STTC-542 STTC-042 STTC-142 STTC-842V1 STTC-842	Long Reach Chisel 60° 1.78mm x 16mm (.07" x .63")

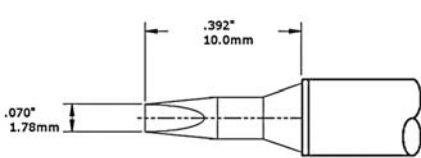
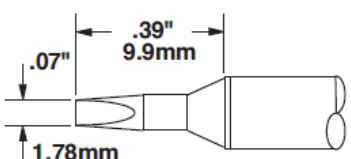
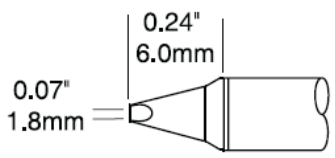
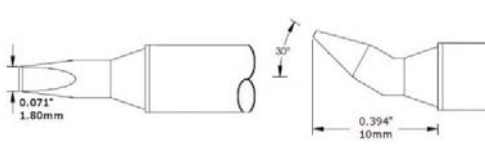
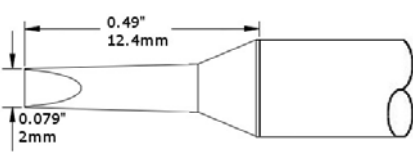
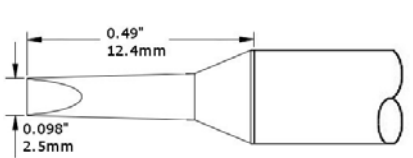
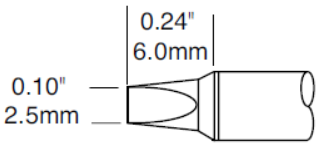
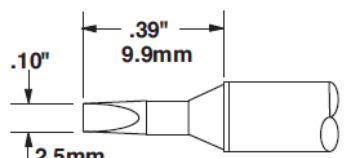
Chisel			
	CVC-5CH0018L CVC-6CH0018L CVC-7CH0018L CVC-8CH0018L CVC-9CH0018L	STTC-537LL STTC-037LL STTC-137LL STTC-837LLV1 STTC-837LL	Chisel 30° Long Life 1.78mm x 1.0mm (.07" x .24")
	CVC-5CH0018S CVC-6CH0018S CVC-7CH0018S CVC-8CH0018S CVC-9CH0018S	STTC-537 STTC-037 STTC-137 STTC-837V1 STTC-837	Chisel Solder 30° 1.78mm x 9.9mm (.07" x .39")
	CVC-5CH0018P CVC-6CH0018P CVC-7CH0018P CVC-8CH0018P CVC-9CH0018P	STTC-537P STTC-037P STTC-137P STTC-837PV1 STTC-837P	Chisel 30° P = Optimised geometry for best thermal performance 1.8mm x 6.0mm (.07" x .24")
	CVC-5CH0018R CVC-6CH0018R CVC-7CH0018R CVC-8CH0018R CVC-9CH0018R	STTC-598 STTC-098 STTC-198 STTC-898V1 STTC-898	Long Reach Chisel 30° 1.8mm x 10.0mm (.07" x 0.4")
	CVC-5CH0020A CVC-6CH0020A CVC-7CH0020A CVC-8CH0020A CVC-9CH0020A	N/A	Long Reach Chisel 2.0mm x 12.4mm (.08" x 0.49")
	CVC-5CH0025A CVC-6CH0025A CVC-7CH0025A CVC-8CH0025A CVC-9CH0025A	N/A	Long Reach Chisel 2.5mm x 12.4mm (.10" x .49")
	CVC-5CH0025P CVC-6CH0025P CVC-7CH0025P CVC-8CH0025P CVC-9CH0025P	STTC-536P STTC-036P STTC-136P STTC-836PV1 STTC-836P	Chisel 30° P = Optimised geometry for best thermal performance 2.5mm x 6.0mm (.10" x .24")
	CVC-5CH0025S CVC-6CH0025S CVC-7CH0025S CVC-8CH0025S CVC-9CH0025S	STTC-536 STTC-036 STTC-136 STTC-836V1 STTC-836	Chisel 30° 2.5mm x 9.9mm (.10" x .39")

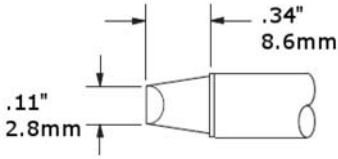
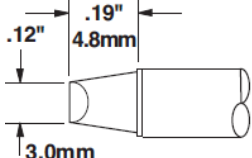
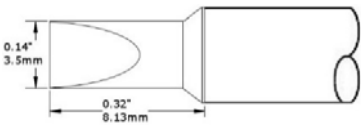
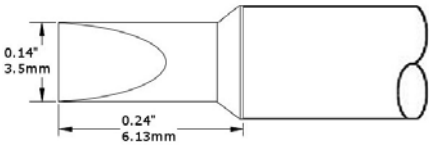
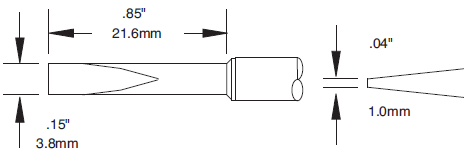
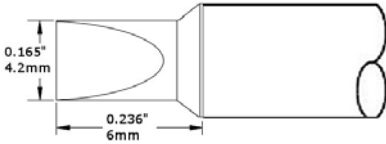
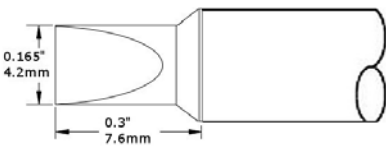
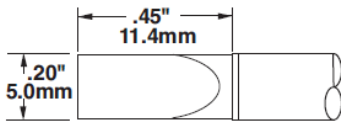
Chisel			
	CVC-5CH0034S CVC-6CH0034S CVC-7CH0034S CVC-8CH0034S CVC-9CH0034S	STTC-503 STTC-003 STTC-103 STTC-803V1 STTC-803	Chisel 90° 2.8mm x 8.6mm (.11" x .34")
	CVC-5CH0030S CVC-6CH0030S CVC-7CH0030S CVC-8CH0030S CVC-9CH0030S	STTC-513 STTC-013 STTC-113 STTC-813V1 STTC-813	Chisel 90° 3.0mm x 4.8mm (.12" x .19")
	CVC-5CH0035S CVC-6CH0035S CVC-7CH0035S CVC-8CH0035S CVC-9CH0035S	N/A	Chisel 3.5mm x 8.13mm (.14" x .32")
	CVC-5CH0035P CVC-6CH0035P CVC-7CH0035P CVC-8CH0035P CVC-9CH0035P	N/A	Chisel P = Optimised geometry for best thermal performance 3.5mm x 6.13mm (.14" x .24")
	CVC-5CH2238A CVC-6CH2238A CVC-7CH2238A CVC-8CH2238A CVC-9CH2238A	STTC-520 STTC-020 STTC-120 STTC-820V1 STTC-820	Long Reach Chisel 12° 3.8mm x 21.6mm (.15" x .85")
	CVC-5CH0040P CVC-6CH0040P CVC-7CH0040P CVC-8CH0040P CVC-9CH0040P	N/A	Chisel P = Optimised geometry for best thermal performance 4.2mm x 6mm (.165" x .24")
	CVC-5CH0040S CVC-6CH0040S CVC-7CH0040S CVC-8CH0040S CVC-9CH0040S	N/A	Chisel 4mm x 7.6mm (.17" x 0.3")
	CVC-5CH0050A CVC-6CH0050A CVC-7CH0050A CVC-8CH0050A CVC-9CH0050A	STTC-565 STTC-065 STTC-165 STTC-865V1 STTC-865	Large Chisel 5.0mm x 11.4mm (.20" x .45")

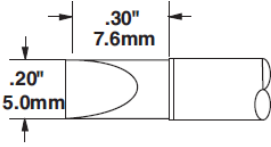
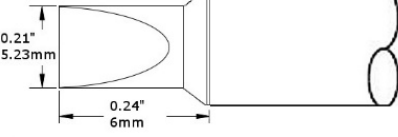
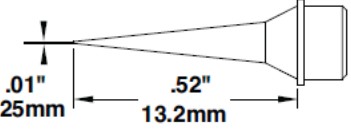
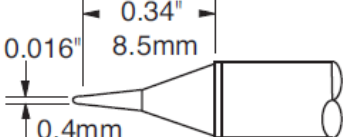
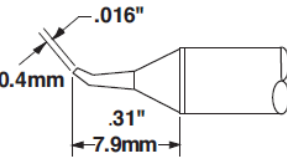
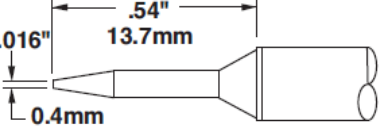
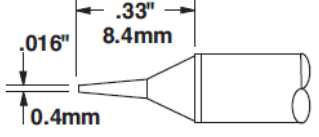
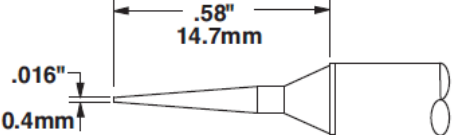
Chisel			
	CVC-5CH0050S CVC-6CH0050S CVC-7CH0050S CVC-8CH0050S CVC-9CH0050S	STTC-517 STTC-017 STTC-117 STTC-817V1 STTC-817	Large Chisel 5.0mm x 7.6mm (.20" x .30")
	CVC-5CH0050P CVC-6CH0050P CVC-7CH0050P CVC-8CH0050P CVC-9CH0050P	N/A	Chisel P = Optimised geometry for best thermal performance 5.2mm x 6mm (.21" x .24")
Conical			
	CVC-5CN0003A CVC-6CN0003A CVC-7CN0003A CVC-8CN0003A CVC-9CN0003A	STTC-590 STTC-090 STTC-190 STTC-890V1 STTC-890	Fine and Long Reach Conical 0.25mm x 13.2mm (.01" x .52")
	CVC-5CN0004P CVC-6CN0004P CVC-7CN0004P CVC-8CN0004P CVC-9CN0004P	STTC-545P STTC-045P STTC-145P STTC-845PV1 STTC-845P	Conical Sharp P = Optimised geometry for best thermal performance 0.4mm x 8.5mm (.016" x .34")
	CVC-5CN0004R CVC-6CN0004R CVC-7CN0004R CVC-8CN0004R CVC-9CN0004R	STTC-526 STTC-026 STTC-126 STTC-826V1 STTC-826	Conical Sharp Bent 30° 0.4mm x 7.9mm (.016" x .31")
	CVC-5CN1304A CVC-6CN1304A CVC-7CN1304A CVC-8CN1304A CVC-9CN1304A	STTC-506 STTC-006 STTC-106 STTC-806V1 STTC-806	Conical Sharp 0.4mm x 13.7mm (.016" x .54")
	CVC-5CN1404S CVC-6CN1404S CVC-7CN1404S CVC-8CN1404S CVC-9CN1404S	STTC-522 STTC-022 STTC-122 STTC-822V1 STTC-822	Conical Sharp 0.4mm x 8.4mm (.016" x .33")
	CVC-5CN1504A CVC-6CN1504A CVC-7CN1504A CVC-8CN1504A CVC-9CN1504A	STTC-545 STTC-045 STTC-145 STTC-845V1 STTC-845	Conical Sharp 0.4mm x 14.7mm (.016" x .58")

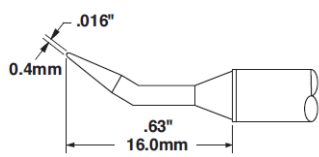
Conical			
	CVC-5CN1604R CVC-6CN1604R CVC-7CN1604R CVC-8CN1604R CVC-9CN1604R	STTC-540 STTC-040 STTC-140 STTC-840V1 STTC-840	Conical Sharp Bent 30° Long Reach 0.4mm x 16mm (.016" x .63")
	CVC-5CN0005A CVC-6CN0005A CVC-7CN0005A CVC-8CN0005A CVC-9CN0005A	STTC-543 STTC-043 STTC-143 STTC-843V1 STTC-843	Conical Sharp 0.5mm x 15.2mm (.02" x .6")
	CVC-5CN0005R CVC-6CN0005R CVC-7CN0005R CVC-8CN0005R CVC-9CN0005R	STTC-544 STTC-044 STTC-144 STTC-844V1 STTC-844	Conical Sharp Bent 30° Long Reach 0.5mm x 14.5mm (.02" x .57")
	CVC-5CN0005S CVC-6CN0005S CVC-7CN0005S CVC-8CN0005S CVC-9CN0005S	STTC-511 STTC-011 STTC-111 STTC-811V1 STTC-811	Conical Sharp 0.5mm x 4.6mm (.02" x .18")
	CVC-5CN4805S CVC-6CN4805S CVC-7CN4805S CVC-8CN4805S CVC-9CN4805S	STTC-516 STTC-016 STTC-116 STTC-816V1 STTC-816	Conical Sharp 0.5mm x 4.8mm (.02" x .19")
	CVC-5CN0010A CVC-6CN0010A CVC-7CN0010A CVC-8CN0010A CVC-9CN0010A	STTC-501 STTC-001 STTC-101 STTC-801V1 STTC-801	Conical 1.0mm x 13.5mm (.04" x .53")
	CVC-5CN0010P CVC-6CN0010P CVC-7CN0010P CVC-8CN0010P CVC-9CN0010P	STTC-501P STTC-001P STTC-101P STTC-801PV1 STTC-801P	Conical P = Optimised geometry for best thermal performance 1.0mm x 6.5mm (.04" x .25")
	CVC-5CN0010S CVC-6CN0010S CVC-7CN0010S CVC-8CN0010S CVC-9CN0010S	STTC-531 STTC-031 STTC-131 STTC-831V1 STTC-831	Conical 1.0mm x 9.9mm (.04" x .39")

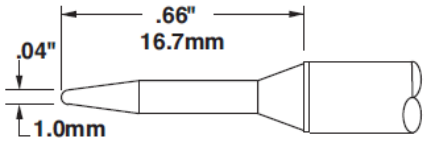
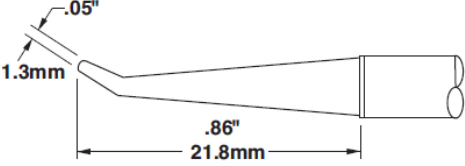
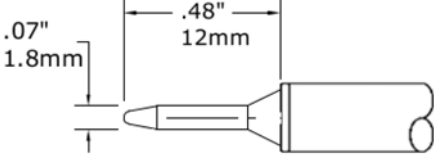
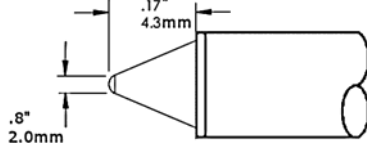
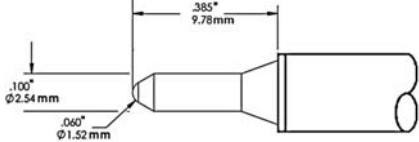
Conical			
	CVC-5CN1710A CVC-6CN1710A CVC-7CN1710A CVC-8CN1710A CVC-9CN1710A	STTC-507 STTC-007 STTC-107 STTC-807V1 STTC-807	Conical 1.0mm x 16.7mm (.04" x .66")
	CVC-5CN0013R CVC-6CN0013R CVC-7CN0013R CVC-8CN0013R CVC-9CN0013R	STTC-541 STTC-041 STTC-141 STTC-841V1 STTC-841	Conical Bent 30° Long Reach 1.3 mm x 21.8mm (.05" x .86")
	CVC-5CN1208S CVC-6CN1208S CVC-7CN1208S CVC-8CN1208S CVC-9CN1208S	STTC-502 STTC-002 STTC-102 STTC-802V1 STTC-802	Conical 1.8mm x 12.0mm (.07" x .48")
	CVC-5CN4302S CVC-6CN4302S CVC-7CN4302S CVC-8CN4302S CVC-9CN4302S	STTC-512 STTC-012 STTC-112 STTC-812V1 STTC-812	Conical 2.0mm x 4.3mm (.8" x .17")
	CVC-5CN1002S CVC-6CN1002S CVC-7CN1002S CVC-8CN1002S CVC-9CN1002S	STTC-532 STTC-032 STTC-132 STTC-832V1 STTC-832	Conical 2.5mm x 9.78mm (.10" x .385")

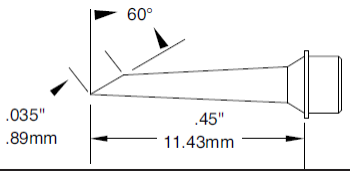
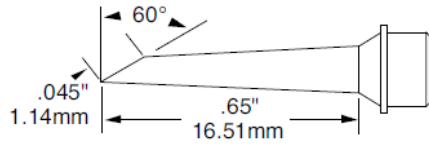
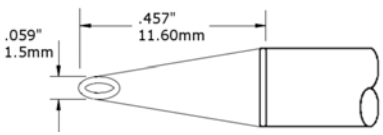
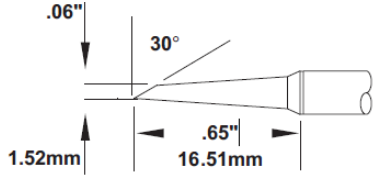
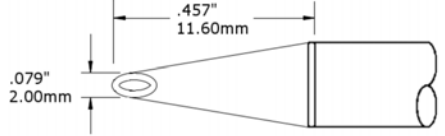
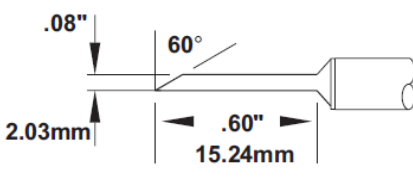
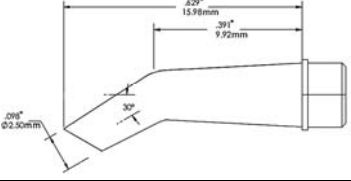
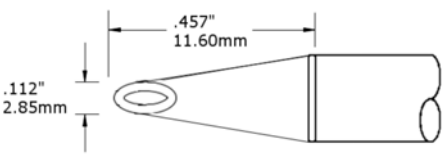
Hoof			
	SMC-5HF6009S SMC-6HF6009S SMC-7HF6009S SMC-8HF6009S SMC-9HF6009S	SMTC-5175 SMTC-0175 SMTC-1175 SMTC-8175V1 SMTC-8175	Micro Hoof 60° 0.89mm x 11.43mm (.035"x.45")
	SMC-5HF6011S SMC-6HF6011S SMC-7HF6011S SMC-8HF6011S SMC-9HF6011S	SMTC-5174 SMTC-0174 SMTC-1174 SMTC-8174V1 SMTC-8174	Micro Hoof 60° Long Reach 1.14mm x 16.51mm (.045"x.65")
	SMC-5HF0015V SMC-6HF0015V SMC-7HF0015V SMC-8HF0015V SMC-9HF0015V	SMTC-5184 SMTC-0184 SMTC-1184 SMTC-8184V1 SMTC-8184	Concave Hoof 1.5mm x 11.6mm
	SMC-5HF6015S SMC-6HF6015S SMC-7HF6015S SMC-8HF6015S SMC-9HF6015S	SMTC-5167 SMTC-0167 SMTC-1167 SMTC-8167V1 SMTC-8167	Hoof 30° Long Reach 1.5mm x 16.51mm (.06"x.65")
	SMC-5HF0020V SMC-6HF0020V SMC-7HF0020V SMC-8HF0020V SMC-9HF0020V	SMTC-5185 SMTC-0185 SMTC-1185 SMTC-8185V1 SMTC-8185	Concave Hoof 2mm x 11.6mm
	SMC-5HF6020S SMC-6HF6020S SMC-7HF6020S SMC-8HF6020S SMC-9HF6020S	SMTC-5169 SMTC-0169 SMTC-1169 SMTC-8169V1 SMTC-8169	Hoof 60° Long Reach 2mm x 15.24mm (.08" x .60")
	SMC-5HF3025S SMC-6HF3025S SMC-7HF3025S SMC-8HF3025S SMC-9HF3025S	SMTC-5183 SMTC-0183 SMTC-1183 SMTC-8183V1 SMTC-8183	Concave Hoof 30° Bent 2.5mm x 16.0mm
	SMC-5HF0030V SMC-6HF0030V SMC-7HF0030V SMC-8HF0030V SMC-9HF0030V	SMTC-5186 SMTC-0186 SMTC-1186 SMTC-8186V1 SMTC-8186	Concave Hoof 2.85mm x 11.6mm

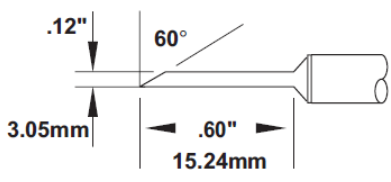
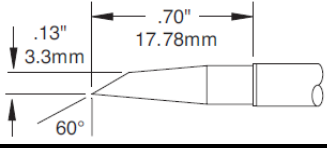
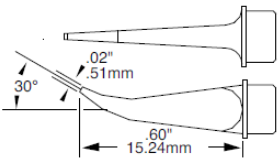
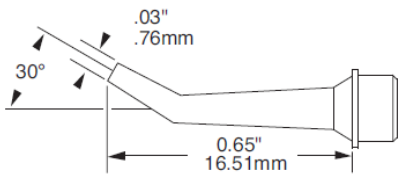
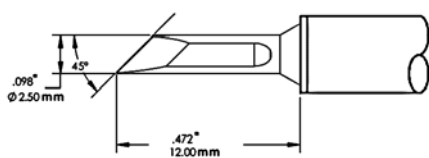
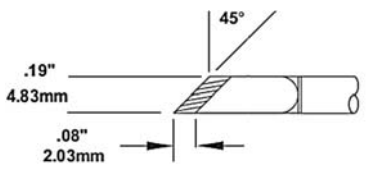
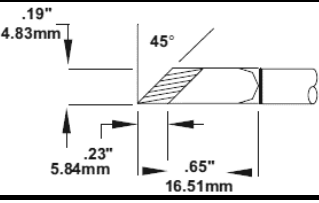
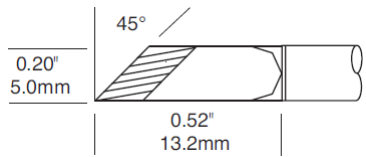
Hoof			
	SMC-5HF6030S SMC-6HF6030S SMC-7HF6030S SMC-8HF6030S SMC-9HF6030S	SMTC-5170 SMTC-0170 SMTC-1170 SMTC-8170V1 SMTC-8170	Hoof 60° Long Reach 3mm x 15.24mm (.12" x .60")
	SMC-5HF6033S SMC-6HF6033S SMC-7HF6033S SMC-8HF6033S SMC-9HF6033S	SMTC-5147 SMTC-0147 SMTC-1147 SMTC-8147V1 SMTC-8147	Hoof 60° Long Reach 3.3mm x 17.78mm (.13" x .70")
Hook			
	SMC-5HK0005S SMC-6HK0005S SMC-7HK0005S SMC-8HK0005S SMC-9HK0005S	SMTC-5172 SMTC-0172 SMTC-1172 SMTC-8172V1 SMTC-8172	Hook Long 30° 0.5mm x 15.24mm (.02" x .60")
	SMC-5HK0008S SMC-6HK0008S SMC-7HK0008S SMC-8HK0008S SMC-9HK0008S	SMTC-5171 SMTC-0171 SMTC-1171 SMTC-8171V1 SMTC-8171	Conical Bent 30° 0.76mm x 16.51mm (.03" x .65")
Knife			
	SMC-5KN0025S SMC-6KN0025S SMC-7KN0025S SMC-8KN0025S SMC-9KN0025S	SMTC-5165 SMTC-0165 SMTC-1165 SMTC-8165V1 SMTC-8165	Knife 45°, 2.5mm x 12.0mm (.098" x .472")
	SMC-5KN0048S SMC-6KN0048S SMC-7KN0048S SMC-8KN0048S SMC-9KN0048S	SMTC-5161 SMTC-0161 SMTC-1161 SMTC-8161V1 SMTC-8161	Knife 45° - Increased tinned Area Length 2.03mm (.08") 4.8mm x 16.51mm (.18" x .65")
	SMC-5KN0048W SMC-6KN0048W SMC-7KN0048W SMC-8KN0048W SMC-9KN0048W	SMTC-5173 SMTC-0173 SMTC-1173 SMTC-8173V1 SMTC-8173	Knife 45° - Increased tinned Area Length 5.84mm (.23") 4.8mm x 16.51mm (.18" x .65")
	SMC-5KN0050P SMC-6KN0050P SMC-7KN0050P SMC-8KN0050P SMC-9KN0050P	STTC-5173P STTC-0173P STTC-1173P STTC-8173PV1 STTC-8173P	Knife 45°, P = Optimised geometry for best thermal performance 5.0mm x 13.2mm (.20" x .52")

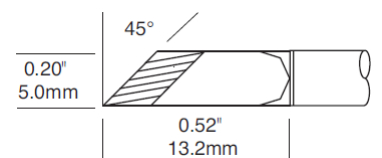
Knife			
	SMC-5KN0050X	STTC-5173PLL	Knife 45°, Long Life, P = Optimised geometry for best thermal performance 5.0mm x 13.2mm (.20" x .52")
	SMC-6KN0050X	STTC-0173PLL	
	SMC-7KN0050X	STTC-1173PLL	
	SMC-8KN0050X	STTC-8173PLLV1	
	SMC-9KN0050X	STTC-8173PLL	

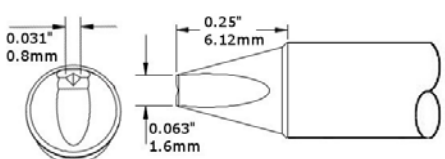
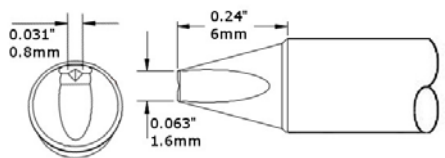
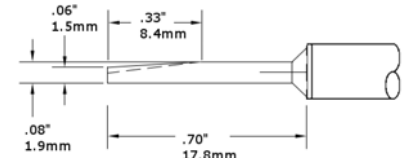
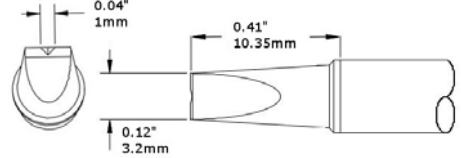
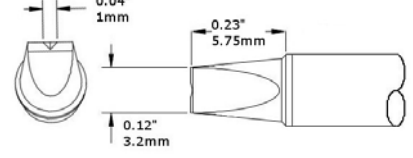
V-Groove			
	CVC-5VG0016A	N/A	V-Groove Chisel 1.6mm x 6.12mm (.06" x .25")
	CVC-6VG0016A		
	CVC-7VG0016A		
	CVC-8VG0016A		
	CVC-9VG0016A		
	CVC-5VG0016P	N/A	V-Groove Chisel P = Optimised geometry for best thermal performance 1.6mm x 6mm (.06" x .24")
	CVC-6VG0016P		
	CVC-7VG0016P		
	CVC-8VG0016P		
	CVC-9VG0016P		
	CVC-5LG1802A	STTC-583	Concave Slot 1.9mm x 17.8mm (.08" x .70")
	CVC-6LG1802A	STTC-083	
	CVC-7LG1802A	STTC-183	
	CVC-8LG1802A	STTC-883V1	
	CVC-9LG1802A	STTC-883	
	CVC-5VG0032A	N/A	V-Groove Chisel 3.2mm x 10.35mm (.12" x .41")
	CVC-6VG0032A		
	CVC-7VG0032A		
	CVC-8VG0032A		
	CVC-9VG0032A		
	CVC-5VG0032P	N/A	V-Groove Chisel P = Optimised geometry for best thermal performance 3.2mm x 5.75mm (.12" x .23")
	CVC-6VG0032P		
	CVC-7VG0032P		
	CVC-8VG0032P		
	CVC-9VG0032P		