

AIS 63X-HW

Inline PCBA 3D Solder Paste Automated Optical inspection equipment

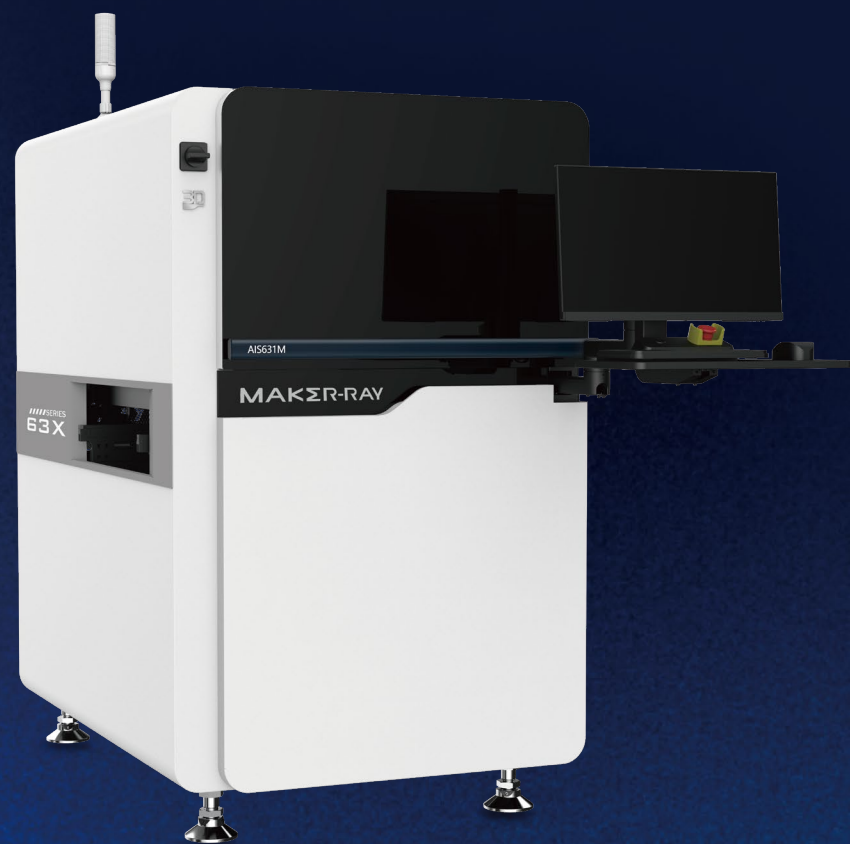

Fast Programming 01

AI intelligent programming double programming efficiency

Low False Calls 02

Strong anti-interference reducing false calls of bridging and solder silk

Comprehensive Data 03

SPC data empowering production management

SPECIFICATION

Category	Item	AIS631MB-HW	AIS631MB-D-HW
	Dimension	50* 50mm- 510* 460mm(Large board mode 710* 460mm)	Single Lane: 50* 50mm-510* 610mm; Dual Lane: 50* 50mm-510* 330mm(Minimum between middle Lane 55mm)
	Thickness	0.5mm-6mm	
Board Info	Height Clearance	900mm	
	Max weight	≤3KG	
	Max Component Height	Top: 25mm. Bottom: 40mm	
	Edge Clearance	3mm	
Vision Module	Camera	5MP high frame rate black and white industrial camera	
	Light Source	RGBW+Projector	
	Resolution & FOV	10um: 24* 20mm/ 15um: 36* 30mm (Option)	
	Inspection Speed	0.28sec/FOV	
Inspection	Main Algorithm	AI Algorithm Mainly: AI Solder Paste Algorithm. Reference plane correction algorithm. Tilt algorithm. Dimension detection algorithm	
	Solder Paste Insoection	Height, area, volume, excessive, insufficient, projections, bridging, XY offset, angle offset, etc.	
	Multi-scene Inspection	Support multi-panel, mixed components, spot inspection, random inspection, etc.	
Programming	Programming Method	Support importing Gerber file. Quick Programming: Intelligently realize auto-search and drawing of detection frames for the solder paste and configure algorithms	
	In-line on fly programming and finetuning	Feature allow users perform programming , components changes or parameters updates without stop or distract the active production line.	
Other Features	Barcode Identification	1D / 2D barcode & QR code identification(5*5mm above)	
	Statistical Data Analysis	Software solution to display AOI inspection record, analysis, graph and chart plotting. Extract data summary in excel or .csv file format.	
Hardware	Industrial Computer	CPU: intel i7 Graphics: Nvidia RTX3050 Memory: 32G DDR4, 256G SSD+2T HDD Network: 1000M Network card	
	Display	23.8 inch	
	Operating System	Ubuntu 18.04 LTS 64bit	
	Communication	Standard SMEMA interface	
	Width Adjustment	Manual/automatic	
	Motion Structure	High precision screw + servo motor	
	Dimension and Weight	(L* H* D)1015* 1670* 1445mm (Tower light excluded), 807Kg	(L* H* D)1015* 1670* 1695mm (Tower light excluded), 1000Kg
Power Supply and Power	AC 220V. Rated power 510W		
Air	0.4-0.6Mpa		
Environmental Requirements	Temperature: 10~45°C. Humidity: 30~85%RH		

WWW.MAKER-RAY.COM

(+86)020-86154335

MKR-AOI@MAKER-RAY.COM

NO. 6, YUNPU 4TH ROAD, HUANGPU DISTRICT, GUANGZHOU, GUANGDONG PROVINCE, CHINA



LinkedIn

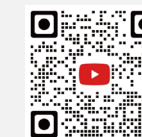

YouTube

● CORE ADVANTAGES

Specific light source technology. Highly restore solder paste imaging

High-precision, high-speed industrial cameras and professional optical imaging systems adapt to the identification of PCB solder pastes of different colors and materials, and clearly present solder paste imaging. It can also be used for the detection of red glue, coating thickness, slurry thickness, etc., with stronger expandability.

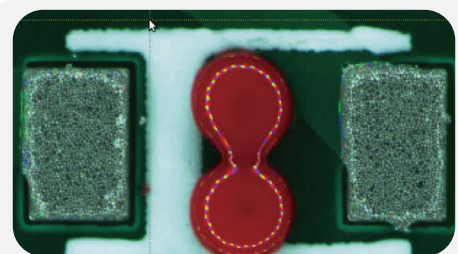

Red glue and solder paste imaging

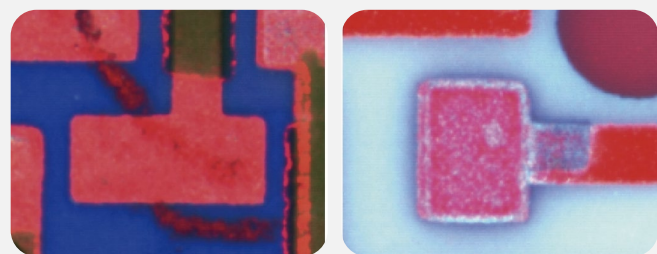

Ceramic plate slurry process imaging

AI intelligent denoising restores the true shape of solder paste

Combining AI image processing technology and field filtering algorithms, it can intelligently distinguish between noise points and real solder paste shape deformity. AI can intelligently remove the interference of noise points to improve measurement accuracy and effectively reduce false calls.

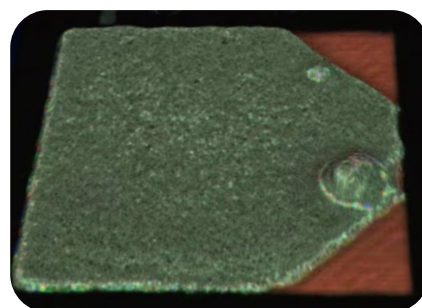

Before denoising

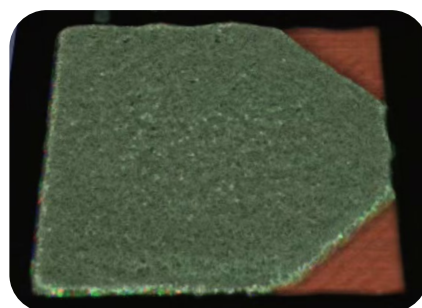

After denoising

AI intelligent programming. User-friendly and efficient

In the absence of GERBER, AI can auto-identify solder paste areas, generate a whole board image with one click, and intelligently configure parameters without relying on engineer experience to ensure higher program consistency.

It also supports importing GERBER files, automatically generating solder paste detection frames and configuring parameters, saving programming time and improving efficiency.

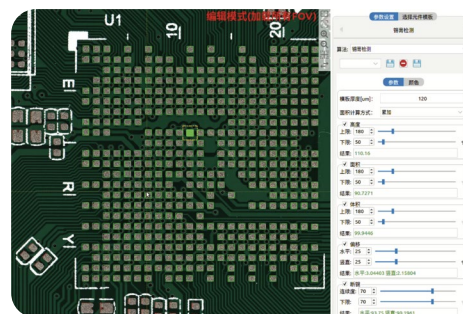

Automatically select solder paste area

● MORE FUNCTIONS



Three-point matching integrates multi-station data to assist in quickly locating abnormal causes

Integrating the data of SPI, pre-reflow AOI and post-reflow AOI through three-point matching, quickly analyzing product defects, locate the root causes to help engineers develop targeted improvement measures.



Multi-panel program production to improve programming efficiency

In the Multi-panel board mode, after programming is completed, it can be copied to the next board with one click, without manual debugging, auto-identifying components and intelligently configuring parameters, saving repeated programming time.



Complete SPC data, empowering production management

SPC statistical data has rich dimensions and various presentation forms, supports connecting with MES system, and meets the needs of data statistics and analysis.

● ARCHITECTURE DRAWING

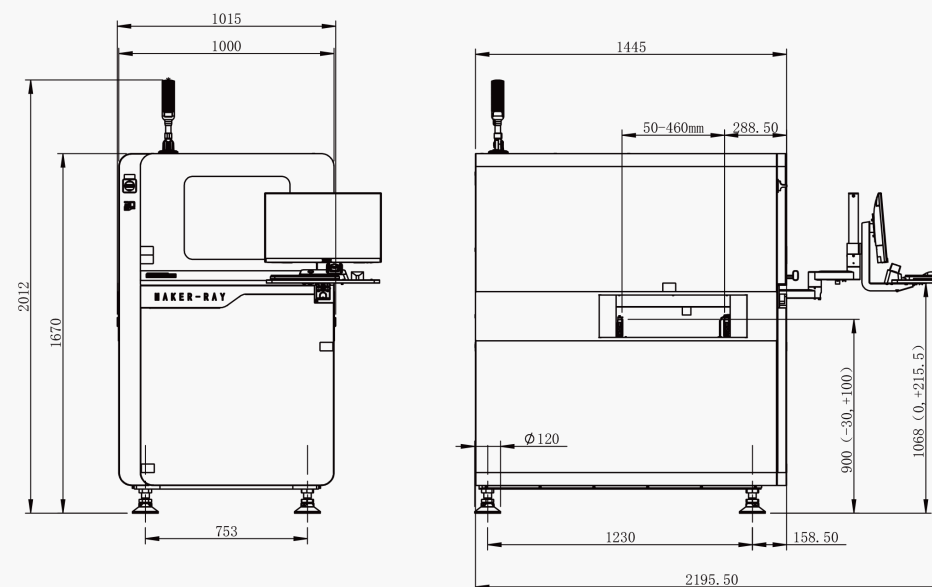

Unit: mm

● APPLICATION SCENARIO

After SMT Printer

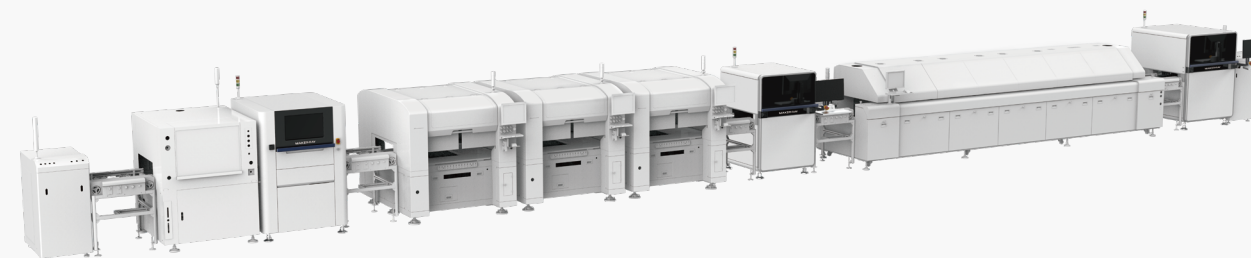

● INSPECTABLE DEFECTS

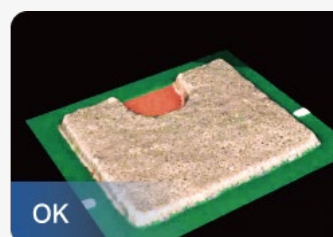

OK

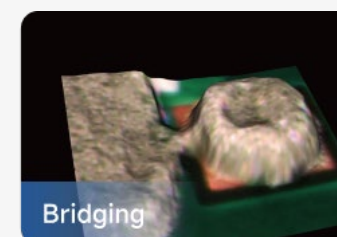

Bridging

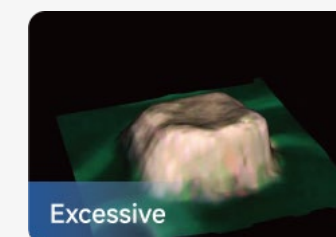

Excessive

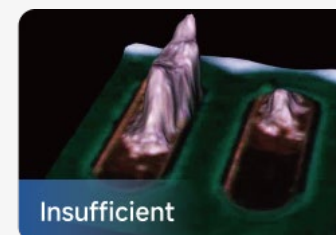

Insufficient

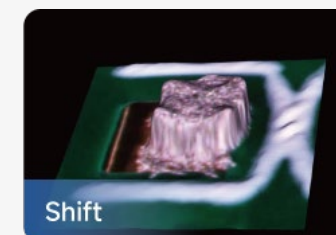

Shift

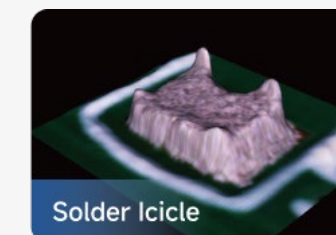

Solder Icicle