

Ersa wave soldering systems

In a class of its own!



Technical Highlights:

- Lowest cost of ownership
- Highest energy efficiency
- Lowest energy consumption
- Highest machine availability
- Extremely service friendly
- Enclosed fluxer with low maintenance
- Free programmable fluxing areas
- Powerful top and bottom heaters
- Individual configuration of the preheat
- Wide choice of solder nozzles for all applications
- Sequential soldering
- Process gas cleaning
- Stable tunnel temperature
- N₂ level independent from the exhaust system
- Flexible conveyor systems to handle all carriers and frames
- Divided conveyor for optimal profiling
- User friendly software
- Ready for traceability



Ersa wave soldering systems

In a class of its own!



The electronics manufacturing industry is faced with constantly increasing demands for efficiency and flexibility. At the same time, its customers require highest quality at unbeatable cheap prices. Manufacturers respond to these increasing, and sometimes conflicting, challenges by adapting their manufacturing facilities and strategies. In this tense atmosphere, modern wave soldering systems are an important part of the economic processing of wired components in mass soldering processes.

The many challenges posed by complex electronic assembly units in the processing stage require modern manufacturing systems that are able to flexibly adapt to the most diverse demands. The Ersa POWERFLOW concept allows, for the first time, to implement these different machine concepts into a system.

Thanks to its modular design, Ersa POWERFLOW is available in a variety of configurations, including a high-end full tunnel inert gas soldering system and open atmosphere wave

soldering systems, all of which stand out in terms of availability, cost effectiveness and quality.

Ersa wave soldering systems include the following systems:

POWERFLOW N₂ POWERFLOW e N₂ ETS 330/250

The POWERFLOW N₂ full tunnel inert gas soldering system represents the maximum expansion stage of this new generation of machines, from which the POWERFLOW e N₂ derives as a partially modular full tunnel system.

The POWERFLOW N₂ comprises several equipment features: fluxer, pre-heating sections and soldering module offer a wide range of configuration options, thanks to which the system can be adapted for special customer requirements. Particularly noteworthy are the pre-heating section and the soldering module. These available options are specifically customised based on the requirements of lead-free soldering

processes and offer a safe base in the production of highly sophisticated and complex assembly units with a high heat capacity.

For manufacturing environments, in which floor space is the main priority, the POWERFLOW e N₂ represents an interesting version. The partially modular design of this series provides all the essential options in a compressed form, which makes the entire system more compact, thus requiring less floor space.

The series of reasonably priced soldering systems is covered by the ETS 330 and ETS 250 systems. These systems are limited in their configuration options and working width, however they offer easy operation thanks to programme-controlled processing of the assembly units that are to be soldered.

Thanks to the safety of very stable processes and repeatable parameters, Ersa's wave soldering systems optimise quality, costs and on-time delivery in the manufacturing process of our customers.



Fluxer

Best process safety, even with high throughput

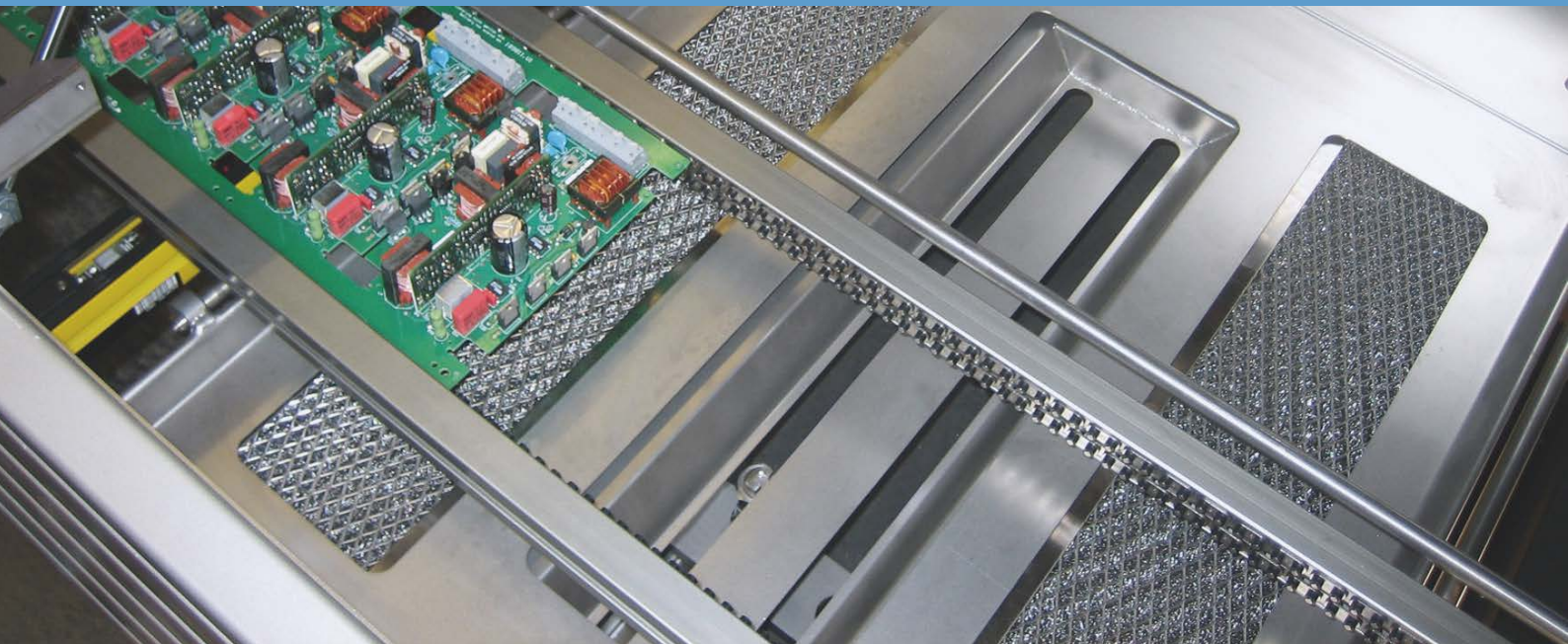

Fluxer – top view

Today, spray systems are standard equipment for any wave soldering machine, however they differ significantly in detail. Erska offers many innovative solutions for the fluxer.

Particular attention is paid not only to the safety of systems but also to their cost effectiveness, i.e. flux material consumption and processing speed.

Using high quality materials enables the use of VOC-free flux materials.

Spray sections for specific products can be entered graphically on ER-SASOFT. This highly convenient type of process planning helps to greatly reduce flux material consumption.

If during the production process there is no guarantee that the assembly units are always inserted in the same position into the solder frames, the PCB scanner can automatically detect the outline of the PCB in order to apply the targeted flux material.

Technical highlights:

- Economical
- Easy to maintain
- 2 spray heads
- Easy to program
- Standard containers up to 25 liters

The spray systems are supplied directly from standard containers. Therefore, the decanting of flux material into solid tanks can be avoided, thus offering maximum safety.

Wave soldering machines also offer appropriate options for the continuous monitoring of flux material levels and flux material consumption.

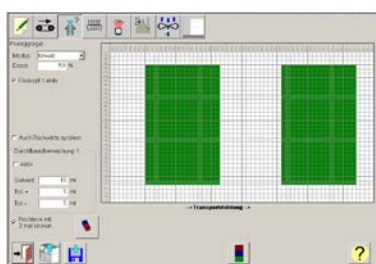

Entry mask for sequential fluxing



Ersa POWERFLUX

Selective fluxing with high precision

Selective fluxer for a waste-free flux application



Ersa POWERFLUX was developed for the fluxing of assembly units, which are transported in solder masks. The solder masks are often used here to cover already reflow soldered SMT components on the wave soldering side. THT components for the wave soldering process can be found in the open sectors of solder masks.

In a conventional wave soldering process, flux material is applied with spray fluxers. These apply the flux material uniformly and smoothly over the entire solder mask and PCB. This conventional flux process offers two huge potentials for improvement. On the one hand, the flux material must not necessarily be applied on the solder mask. On the other hand, the flux material usually crawls into the capillary gap, which automatically forms between the PCB and the solder mask, along the mask openings.

This flux material, which crawls under the mask, can lead to adverse long-term effects on the assembly unit if it comes into contact with flux material residues from the SMT process.

The Ersa POWERFLUX exploits this potential for improvement, since, as with an ink-jet printer, it applies the flux material only to the sections of the assembly unit that are also wave soldered. The solder masks stay dry and the flux material manages not to enter the capillary gap between the assembly unit and the solder mask.

Technical highlights:

- Lower flux material consumption
- Reduced soiling of solder masks
- Reduced need of cleaning solder masks
- Longer shelf life of solder masks
- No contamination in sectors covered by SMD due to the wave soldering flux material

Multi-nozzle flux system consisting of 4 spray heads

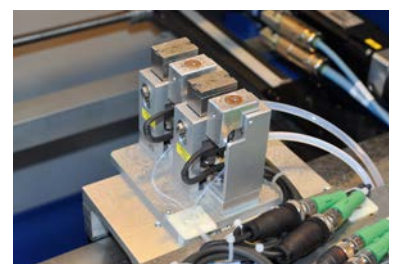

Pre-heating

flexible, efficient, uniform, stable, repeatable

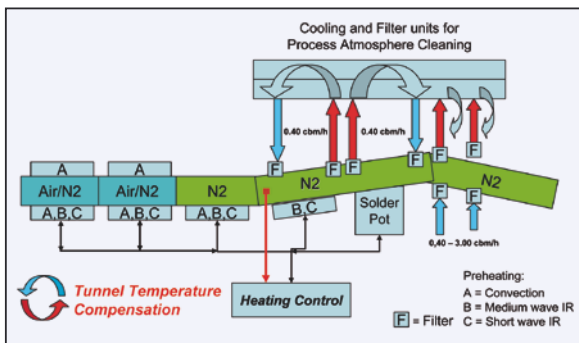

Functional diagram of the inert gas tunnel of the Ersä POWERFLOW N₂ with atmospheric cleaning and temperature compensation of pre-heating sections

The pre-heating process plays a key role during lead-free soldering, since a substantial portion of the required soldering heat demand is transmitted here. The pre-heating section of the POWERFLOW makes sure that, under all operating conditions, the pre-heating process runs in a stable way and is repeatable. It also ensures that set temperature profiles and process windows are observed.

Short-wave infrared emitters transfer the different energy amounts almost without inertia.

Thanks to convection modules, which can be arranged below or above PCB conveyors, PCBs can be gently, uniformly and very effectively heated, whereby heat loss and high temperature differences are minimised. Medium-wave emitters also support homogeneous heating of high-mass PCBs.

The speed-controlled blower motors enable the implementation of different heat transfer rates at a constant temperature, which, in turn, is a great advantage in the event of mixed throughput of assembly units.

With the freely configurable pre-heating section, even the greatest demands can be covered.

Technical highlights:

- Variable in length and combination
- Convection from below and above
- Pyrometer control
- Tunnel temperature compensation

In addition, the POWERFLOW features automatic temperature compensation. The heating of the system tunnel is measured at suitable points and corrects the temperatures of the pre-heater module accordingly with complex algorithms. In this way, constant operating conditions can be ensured despite variable energy output.

Pyrometers for interactive temperature control or for documentation and future traceability of the PCB temperature are also available as an option.

Conveyor

flexible concepts for all requirements



Process tunnel

For PCB conveying in the soldering system, options include systems with solder frames and finger conveyors.

The solder frame conveyor is rested on a robust pin chain, which is guided into a profile. Thanks to simple adjustments to the system, solder frames from external manufacturers can also be conveyed. Replacing a third-party make with a wave soldering machine manufactured by Erska enables existing solder frames to continue to be used, and investing in new solder frames is no longer necessary.

As an option, the frame conveyor system can be separated after pre-heating. In this case, soldering module conveying has a separate drive. Hence, different speeds can be adjusted in the flux, pre-heating and soldering sections.

The finger conveyor system can be used for conveying bare PCBs, as well as masks. A motor-driven centre support can be positioned and controlled by a programme in order to prevent bending of wide PCBs.

Precise PCB tracking allows maximum throughput rates, since PCBs or solder frames are conveyed through the machine almost without separation gaps. Standardised interfaces ensure a smooth transition of PCBs from and to the connected peripheral devices.

Technical highlights:

- Frame or finger conveyor
- Shared conveyor
- Use of third-party frames
- Sturdy chain instead of conveyor belts
- Low maintenance
- Flexible speeds
- Precision

Soldering module

Innovations for demanding lead-free applications



POWER-WAVE nozzle

With regard to soldering modules, POWERFLOW N₂ resorts to the proven Ersa double wave soldering technology, on the basis of which the solder unit has been completely redesigned in order to meet the (increasing) market requirements and needs.

The solder unit is designed to be user-friendly and allows the use of a wide range of different solder nozzles. The combination of solder nozzles can be optimally adapted to user needs.

All relevant parameters of the solder units are continuously monitored, including the temperature of the solder, the solder level in the solder pot, the speed of the solder pump drive, the supply of solder bars in the

automatic soldering supply, as well as residual oxygen content of the inert gas atmosphere in full tunnel systems.

The distance between the solder nozzle and the PCB can be easily adjusted from the outside, without having to open the tunnel. Alternatively, this can also be done automatically through optional actuators, whereby these parameters, as well as all other assembly unit-specific soldering parameters, are stored in the soldering programme used.

Technical highlights:

- Lead-free
- Double soldering module
- Nozzle height adjustment (manual and automatic)
- Easy maintenance: The nozzle shaft can be removed without tools; the support stand is housed in the machine
- Solder nozzle combinations for different applications/Vario Wave
- Exchange solder pot with trolley and heat-up station
- Soldering bar supply with monitoring for all commercially available bar formats
- Sequential soldering
- User-friendly
- Flexible solder nozzle configuration
- Optimal soldering results



Combination of VARIO-WAVE solder nozzles

For maintenance work, the solder unit is electrically lowered and positioned out of the machine on a support stand. The support stand is integrated directly into the soldering module and, in order to be used, it only needs to be pulled out from the machine. Accessibility of the solder pot for maintenance or repair work can be easily achieved. For example, solder pump, canal and solder nozzle units can be removed from the solder pot without using tools. In addition, during assembly, no tools or any kind of adjustment work are required.

Naturally, a high-quality protective coating on all parts that come into contact with the solder, providing protection against aggressive substances, is included in all Erska wave soldering systems.

A new generation of solder nozzles

The newly developed and patented VARIO-WAVE solder nozzle has been especially adapted and optimised in order to meet the various market requirements. It is suitable as a pre-solder wave and/or final solder wave and offers a variable wetting length of 35 or 65 mm.

The use of two nozzles in a double wave solder unit allows a variable wetting length of 35/65/100/135 mm. Thanks to the combination of the flexible wetting lengths with a high flow speed of the solder, this solder nozzle is also suitable for the assembly units of power electronics with high heat capacity, as well as for assembly units with low energy consumption

Other advantages include:

- Optimal wetting characteristics for critical SMD layouts on the soldering side
- Particularly suitable for selective solder masks with different structure height on the soldering side, where a pressure compensation takes place due to the construction design of the solder nozzle.
- Reduced risk of tearing thanks to optimal flow characteristics
- Consistent positive feedback from customers
- Compatible with older Erska soldering systems
- Suitable for leaded/unleaded double soldering modules, since the functions of pre solder waves and main solder waves are summarised in a solder nozzle

Software

Intuitive and easy to operate

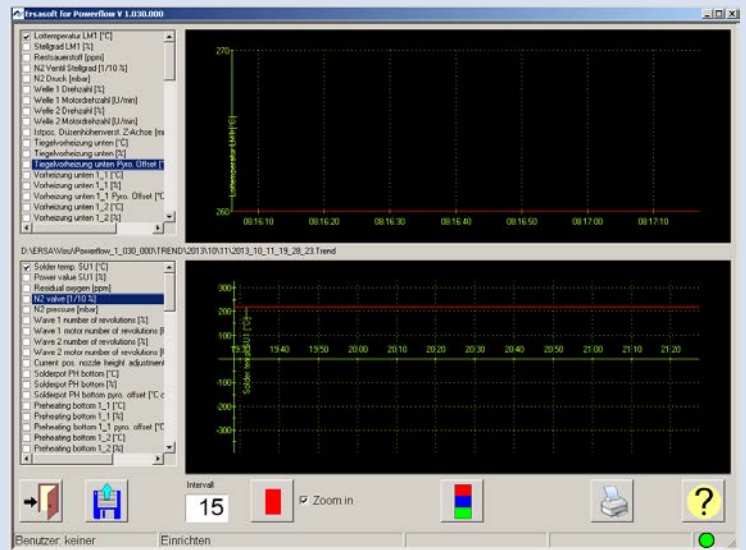
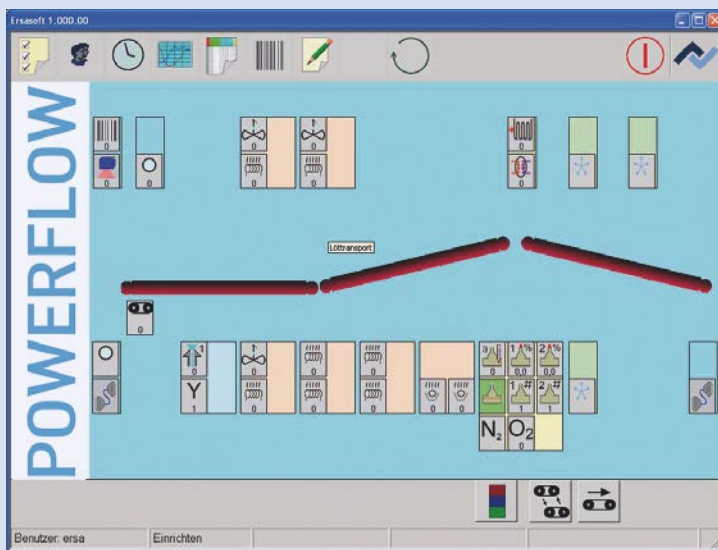

POWERFLOW wave soldering machines are operated via PC control with ERSASOFT. This machine visualisation software offers an extensive range of functions, which support the user during intuitive operation of the machine.

For software interface configuration, all control elements were tailored in order to provide comfortable touch operation. Colour-highlighted and uniformly structured dialogue boxes allow quick orientation and clear separation of input screens, also offering optimal clarity. In this way, the structured design of the software supports intuitive, and therefore easy to learn, machine operation. Moreover, task-related allocation of user rights prevents incorrect machine operation.

For safe machine operation, ERSASOFT displays only the data that matches the actual configuration of the machine. Anyone who has already worked with Ersma Reflow or selective soldering systems can quickly recognise the similar software structure. At the same time, staff training is less required.

The process recorder, which continuously records the actual values of all relevant units for the soldering process, or the soldering report, which stores process data with all necessary traceability information, are standard and owned by ERSASOFT. Similarly, comprehensive alert management is included in the scope of delivery. All arising messages are saved with a time stamp and user ID. This data is available as ASCII data and can therefore be more easily further processed by higher-level systems.

- Highlights:**
- Soldering report, process recorder, alert management (in the scope of delivery)
 - Clear and intuitive operation
 - Comfortable touch operation
 - Downward compatibility

Please note that ERSASOFT is fully backward compatible within a machine generation. In this way, the customer can also take part in innovative software features developed only after the machine is purchased.

Ready for Traceability

Tracing interface for transparent production processes

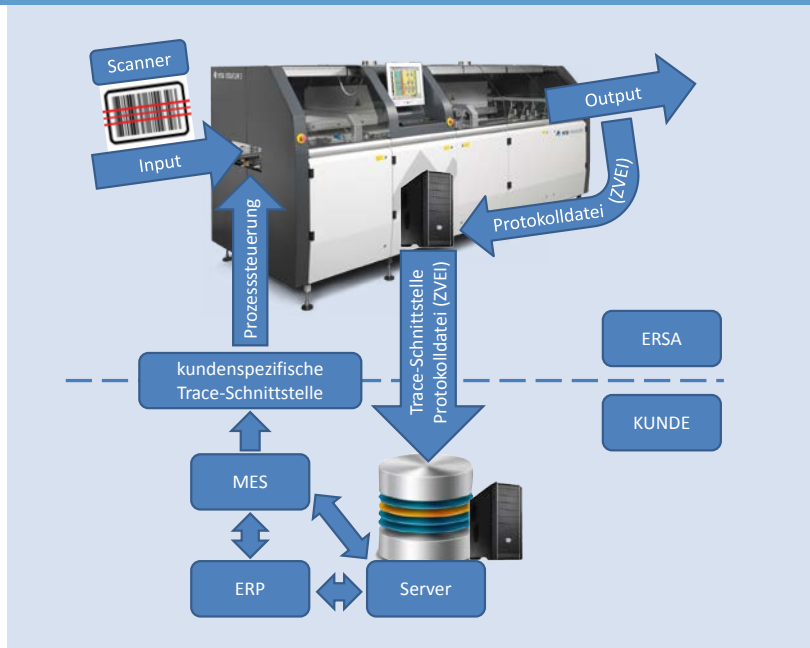

The XML structure of the report file in accordance with the ZVEI standard includes:

Unique ID of processed materials
e.g.: Barcode, matrix code
→ unitname

Machine or workstation
→ equipment

Processing time
→ starttime, endtime

State of processing,
e.g.: ok or nok → state

In addition, as an option, the following values are recorded:

Parameters and reference values
→ processing parameters

Measurement data → measuring

Library name

Soldering programme name

Traceability

The high quality requirements in the electronics manufacturing industry increase the demand for secure product traceability for OEM and EMS companies. For each assembly unit, the exact origin, time of production and manufacturing conditions must be identifiable. Thanks to clear identification, the origin of an end product can be traced back to the individual component throughout the entire supply chain. As a result, errors and their causes can be quickly and safely identified in the event of recall. In this way, any expenses and financial loss for such measures can be strongly reduced.

Ersa has taken up this challenge and, as an option, it has equipped the machines of the POWERFLOW N₂ series with a data interface that complies

with the ZVEI standard. All important process parameters are hereby offered in a higher-level system in an XML structure.

In this way,

- documentation is provided on when and with which process conditions a specific assembly unit was soldered.
- an analysis of process values (process monitoring), concerning permitted limit values, is possible.
- individual serial numbers can be assigned to process data (process tracing).

Traceability and quality assurance of the finished products is therefore guaranteed. Moreover, the Ersa POWERFLOW N₂ can be integrated into the process control of a Manufacturing Execution System (MES). Such systems approve the process

only after checking the plausibility of order data with the wave soldering machine.

Process locking ensures that

- faulty products will not be further produced.
- wrong products are identified and discharged.
- the process sequence is maintained.

A specially developed interface enables coupling with almost all MES available on the market.

Ersa POWERFLOW N₂

The solution for demanding jobs



Technical highlights:

- Extremely high throughput rates
- Process gas purification
- Sequential soldering
- Motor-driven spray head axis
- Comprehensive software features
- Spray area programming
- Automatic spray area acquisition

POWERFLOW is a carrier of technology in the field of wave soldering systems. The system stands out for its wide range of options and can be individually adapted to the most diverse requirements.

The fluxer can be equipped with two independent flux material supply systems. Suction above and below the assembly unit, as well as a separate conveyor system, ensure maximum cleanliness for the process tunnel. For maintenance works, the entire spraying unit can be extended out of the machine.

The length of the pre-heating sections enables the manufacturing of assembly units with high mass while maintaining a high throughput. Medium and short wave infrared emitters and convection heating are available as heating modules.

For the solder unit, which is very easy to maintain, different solder nozzle combinations are also available. Wetting times and solder wave heights are very flexible and allow high clearance in order to optimise soldering parameters individually for each assembly unit. If different solder alloys are used in current manufacturing, different solutions can be provided. Conveyor systems are available for solder frames or directly for transport of PCBs on finger conveyors.

The process tunnel features process gas purification, which constantly filters out arising impurities. As an option, the residual oxygen content of the inert gas atmosphere is monitored and/or controlled.

System control is carried out via PC thanks to a touch screen monitor. The visualised Ersasoft control

software controls and monitors the entire system. The convenient user interface enables effective, rapid and safe use of the soldering system for the user.

A process recorder works in the background, continuously recording all the relevant data of the soldering system. At the same time, data relevant for manufacturing can be made available on a trace interface for higher-level MES networks. In the opposite direction, a locking process can occur. After a sanity check of order data, the process is approved.

Ersa POWERFLOW e N₂

The compact solution



Technical highlights:

- Low investment volumes
- Convenient floor space
- Modern control concept
- Extractable fluxer module
- Full nitrogen tunnel
- Different preheating systems available
- Finger or frame conveyor

The POWERFLOW e N₂ creates the basis for a cost effective soldering system platform. Its equipment options can be compared to the POWERFLOW, however, with limited availability and functionality. As a result, investment costs for these soldering systems are lower and less floor space is required compared to the POWERFLOW.

The pneumatically-driven flexible and programmable spray fluxer is equipped with a spray head and supplied with flux material from the original container.

With regard to pre-heating, the POWERFLOW e N₂ offers the option to extend process length. Options include medium or short wave infrared emitters or compressed air convection modules. Similarly, convection heaters can be installed above the conveyor system in the system tunnel.

The soldering module is designed as a double wave unit and offers, without limitation, the opportunity to use the wide range of proven Ersa solder nozzles. The parameters of the soldering module, which are relevant for manufacturing, are continuously monitored by the system control.

As a conveyor system, solder frames or finger conveyor systems are also available.

The POWERFLOW e N₂ is operated via a 5.7" touch panel or via PC. The optional machine PC offers an extensive range of functions for the user, such as a display for the process recorder and the soldering report.

The software is neatly designed and allows intuitive and safe handling of the machine for the user. The control system offers the opportunity to store up

to 99 soldering programmes, which can be activated manually or via a coding on the solder frames. A weekly time switch ensures operational readiness in time for the start of a shift. The control system continuously monitors all relevant unit states and shows their actual values and operating conditions on the operating panel.

All these features ensure a safe, stable and repeatable soldering process.

Ersa ETS 250 and ETS 330

The solution for small and medium-size series



The compact wave soldering machines of the ETS series offer, together with customer low acquisition and operating costs, the best preconditions. Therefore, even small series of assembly units can be manufactured professionally and cost-effectively. Investing less money does not mean compromising the soldering process. For assembly unit conveying, the machines use the Ersa standard solder frames.

The fluxer is designed as a spray flux system and, in order to ensure repeatable processes, pre-heating offers temperature control and a programmable holding time of assembly units. In this way, despite construction-related short pre-heating, longer heating time is allowed.

The soldering module contains an enamelled steel solder pot, which,

as an option, can be equipped with a second wave shaper.

ETS machines are operated via a 5.7" touch panel. The clear visualisation structure ensures intuitive and safe operation, making it easy to handle for all employees. The software can manage 99 soldering programmes and offers a weekly time switch and a solder frame counter. All unit conditions are clearly shown and the actual values of temperatures and speeds are displayed as plain text. Continuous monitoring of the machine and the recording of all necessary operating data ensure a safe and repeatable soldering process.

The conveyor system of the ETS 250 can process solder frames with a width of 250 mm. While the ETS 250 is designed for manual feeding, this can also be carried out automatically

Technical highlights:

- Frame conveyor system
- Temperature-controlled pre-heating
- Double wave soldering module
- In-line chaining (ETS 330)
- Modern control system with touch operator interface including weekly time switch & management of 99 soldering programmes

by the ETS 330 via an inline interface. The ETS 330 can also process solder frames with a width of 330 mm.

Thanks to a small investment, both machines allow a payback of initial costs in the shortest possible time, even in the event of low proceeds of the products to be manufactured.

Ersa Services

Our global commitment for your success



Customers and interested parties are pleased to use Ersa application centres in order to perform test solderings or to test the efficiency of systems

In line with our company philosophy, we offer services and solution packages, which help to optimise the production processes of our customers.

At Ersa, we are proud to offer comprehensive professional advice. Our advice concerns not only process-related issues but also the economic aspects of the Total Cost of Ownership. At our fully equipped application centres in Europe, North America and China, customers can identify, with the support of our application experts, optimal process parameters for their assembly units. Customers can also send us their assembly units for profile creation or post-processing. Naturally, process support is also provided on site by our team of experts.

With now more than 5,500 satisfied participants, the Ersa know-how

seminar series established itself in the industry several years ago as an appreciated opportunity to provide qualification for its staff.

Certified as a training centre of the DVS, Ersa also trains manual soldering operators in accordance with unified standards. Intensive theoretical and practical professional knowledge and skills are taught during 5-day courses, which, in practice, help to save costs and avoid errors during soldering, desoldering or rework.

Furthermore, we offer customised service packages and TCO (Total Cost of Ownership) consulting. Naturally, our 24-hour spare parts and maintenance service is available worldwide to customers for any problems.

Ersa is particularly renowned for providing know-how in the form of staff training and seminars

Electronics Production Equipment Present in 135 countries

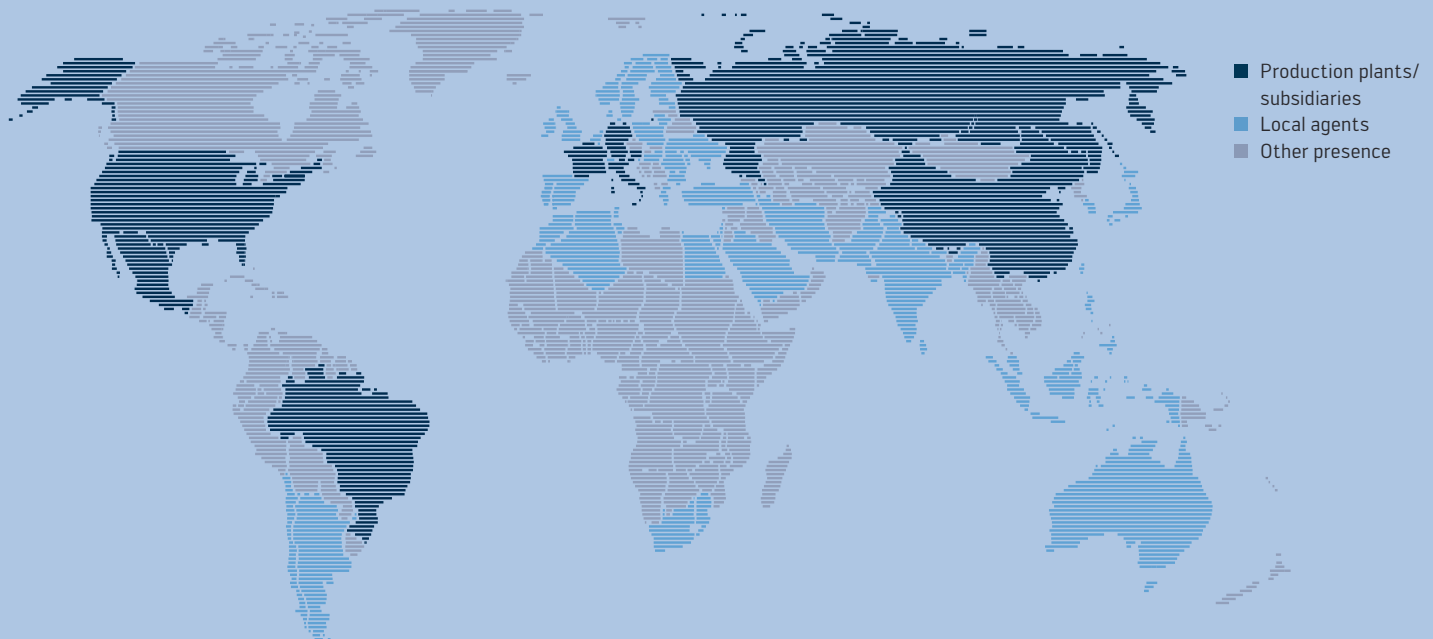

America
Ersa North America
1779 Pilgrim Road
Plymouth, WI 53073
USA
Tel. 800-363-3772
Fax +1 920-893-3322
info-ena@kurtzera.com
www.ersa.com

Mexico
Kurtz Ersa S.A. de C.V.
Mexico City
info-kmx@kurtzera.com
www.ersa.com

Asia
Ersa Asia Pacific
Flat A, 12/F, Max Share Centre
373 King's Road
North Point, Hong Kong
China
Tel. +852 2331 2232
Fax +852 2758 7749
info-eap@kurtzera.com
www.ersa.com

China
Ersa Shanghai
Room 720, Tian Xiang Building
No. 1068 Mao Tai Rd.,
Shanghai 200336, China
Tel. +86 213126 0818
Fax +86 215239 2001
info-eap@kurtzera.com
www.ersa.com

Ersa France
Division de
Kurtz France S.A.R.L
15 rue de la Sucharde
21800 Chevigny Saint Sauveur
France
Tel. +33 3 80 56 66 10
Fax +33 3 80 56 66 16
info@ersa-electronics.fr
www.ersa-electronics.fr

Kurtz Holding GmbH & Co.
Beteiligungs KG
Frankenstr. 2
97892 Kreuzwertheim
Germany
Tel. +49 9342 807-0
Fax +49 9342 807-404
info@kurtzera.de
www.kurtzera.com

Ersa GmbH
Leonhard-Karl-Str. 24
97877 Wertheim/Germany

Tel. +49 9342 800-0
Fax +49 9342 800-127
info@ersa.de
www.ersa.com

 **kurtz ersa**